

# FLOW DISTRIBUTION CONTROL IN MICRO-SCALE VIA ELECTROHYDRODYNAMIC CONDUCTION PUMPING

Michal Talmor, Lei Yang, Thomas R. Larkin,  
Omesh K. Kamat, Tobin J. Dancy, Jamal Seyed-Yagoobi

Multi-Scale Heat Transfer Laboratory  
Department of Mechanical Engineering  
Worcester Polytechnic Institute

Worcester, Massachusetts, 01609

phone: 508-831-5236

e-mail: [mtalmor@wpi.edu](mailto:mtalmor@wpi.edu), [lyang3@wpi.edu](mailto:lyang3@wpi.edu), [trlarkin@wpi.edu](mailto:trlarkin@wpi.edu),  
[okkamat@wpi.edu](mailto:okkamat@wpi.edu), [tjdancy@wpi.edu](mailto:tjdancy@wpi.edu), [jyagoobi@wpi.edu](mailto:jyagoobi@wpi.edu)

**Abstract**— Electrohydrodynamic (EHD) conduction pumping technology offers a unique way to control flow distribution in multi-scale environments. In EHD conduction, the interaction between an applied electrical field and dissociated electrolyte species in a dielectric fluid generates a net body force within the fluid resulting in a net flow in the desired direction. EHD conduction pumps have remarkable potential due to their lack of moving parts, simple designs, low power consumption, and ability to operate in microgravity. The performance of these pumps increases at small scales and they have been previously proven effective for heat transfer enhancement, with possible applications in electronics cooling and more, both terrestrially and in space. Flow distribution control using EHD conduction pumps has been previously examined in macro- and meso-scale configurations, confirming effective redistribution of flow and recovery from mal-distribution, in single and two-phase flows, at those size scales. This study examines single-phase flow distribution control among two parallel micro-channels, 500 microns tall, via upstream EHD conduction pumps. The working fluid was the refrigerant R-123 operated at ambient conditions.

## I. INTRODUCTION

Flow distribution control is an essential capability for modern day fluid based thermal control systems, where the needs of the system can vary from one moment to the next. Smart, automated control and near-immediate response times are desirable characteristics for systems that can redistribute flow to areas of need in real time. Much like electric smart grids, such a system would also be able to minimize the power costs of controlling the flow during times when the heat loads are reduced. Longevity, ease of operation and ease of maintenance are similarly desirable to reduce the costs and increase the robustness of the overall flow control system. In macro-scale flows, there are many flow distribution solutions available on the market using traditional fluid pumps. Yet, as innovations lead to further miniaturization of technology, fluid-based thermal control systems

for high power electronics can no longer effectively utilize traditional solutions involving large, vibrating machinery with many moving elements. The need for a flow distribution control systems at the meso-, micro- and even nano-scales requires non-traditional, innovative flow control solutions that are robust yet simple, consume less power, are easily maintainable and are still effective at manipulating flows when scaled down to these smaller scales.

An example of such a non-traditional innovation is an electrohydrodynamic (EHD) conduction based flow generation and distribution control system. Electrohydrodynamics is the study of the interactions between applied electric fields and fluid flow fields. In all EHD phenomena, fluid motion is caused by charges in the working fluid migrating under the effect of an applied electric field, and carrying the surrounding fluid medium with them, thereby generating fluid motion. In EHD conduction pumping, this fluid motion is achieved by applying a strong electric field between electrodes submerged within a dielectric working fluid. In dielectric fluids, in the absence of a strong electric field, naturally present electrolyte impurities dissociate into charged ions and recombine back into neutral particles at an equal rate [1]. The general reaction is given in (1).

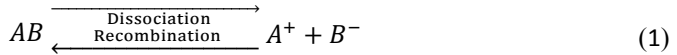

where  $A^+$  is the positive ionic species,  $B^-$  is the negative ionic species, and  $AB$  is the neutrally charged electrolyte particle. Under the effect of a strong electric field, above a critical threshold on the order of 1kV/cm, the rate of dissociation increases while the rate of recombination remains relatively constant. The sudden excess of ionic charges are attracted to the nearby oppositely charged electrodes and form uniformly charged layers over each of the electrodes, referred to as the heterocharge layers. These layers represent local regions of space charges near the electrodes. Opposing Coulomb forces are then applied onto the working fluid due to the presence of these space charges. If the high voltage and ground electrodes have identical wetted surface area (symmetrical electrodes), and the ionic mobilities are the same for both negative and positive species, the opposing Coulomb forces exerted on the fluid are equal in magnitude for both the negative and positive space charges, and only flow circulation occurs between the electrodes. However, purposeful asymmetry in the electrode design causes a force imbalance that generates a net flow [2].

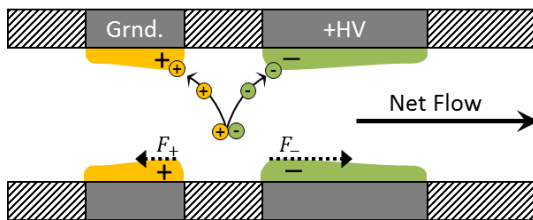

Fig. 1. EHD conduction pumping mechanism

Fig. 1 schematically shows this mechanism for a single electrode pair with the heterocharge layers illustrated over each electrode surface. Since the magnitudes of the applied forces on the fluid depend on the electrode dimensions, the force attracting the negative

charge carriers to the high voltage electrode would be larger than the force attracting positive charge carriers to the ground electrode in this figure, leading to a net force and a net flow as shown. Numerical investigations by Yazdani and Yagoobi [3] have confirmed that, under the assumption of equal charge mobility for both positive and negative ions [4], the net flow direction is always toward the electrode with higher wetted surface area, regardless of the polarity of the individual electrodes.

Due to this flow generation mechanism, EHD conduction pumps contain no moving parts and their performance is entirely controlled by the applied voltage between the electrodes. Although this voltage is high, in order to generate the strong electric field, the consumed current is only on the order of  $\mu\text{A}$ , resulting in little power consumption - on the order of a few Watts or less. EHD conduction pumps can contain several electrode pairs, spaced out such that the electric field of each pair does not interfere with neighboring pairs. Jeong and Seyed-Yagoobi [5] have shown improvement in performance increases quasi-linearly with the number of electrode pairs in a single pump. Theoretical studies of EHD conduction by Atten and Seyed-Yagoobi [6] have shown that EHD pumps are capable of generating significant pressure and flow rates. Experimental work by Mahmoudi et al., Pearson et al. and Patel et al. [7]-[9] have confirmed that these devices are capable of generating useful pressure and fluid flow in macro-, meso-, and micro- scales. A comparative study performed by Pearson and Seyed-Yagoobi [10] showed that EHD conduction performance significantly improves with decreasing size scales, and that careful selection of the electrode geometries can significantly change the pressure and flow rate generation performance of the final pump. These properties make EHD conduction pumps highly customizable and scalable to the performance needs for any given thermal management challenge. However, these single phase studies have focused only on a single branch, without studying flow distribution control between multiple branches.

Feng and Seyed-Yagoobi [11] previously studied single phase flow generation and distribution control in a macro-scale, simple two branch system. In their experimental study, a single EHD pump in one branch (the "active" branch) was able to redirect the flow generated by an upstream mechanical pump from the other branch (the "inactive" branch), until the inactive branch was entirely starved of flow at the maximum operational voltage of the active branch's pump. More recently, Yang et al. [12] studied and characterized the performance of an EHD conduction driven, single phase flow distribution system in meso-scale in a three-branch system. The results of that study showed that EHD conduction driven flow distribution works well in meso-scale and in more complex systems, and that both flow redistribution and maldistribution recovery is possible using EHD conduction pumps. In addition, that study showed that the trends of behavior for such a system could be reasonably predicted via simplified simulations based solely on pre-obtained performance curves for the EHD conduction pumps to be used. Representative results from that study, for flow redistribution and maldistribution recovery, are shown in Fig. 2 and Fig. 3, respectively.

The current study aims to show that EHD driven, single phase flow distribution control is effective at the micro-scale, which is relevant for many applications in electronics cooling, and to characterize the performance of the distribution system at this size scale. The work presented here is the preliminary characterization of EHD driven flow distribution control between twin parallel, 500 micron tall microchannels.

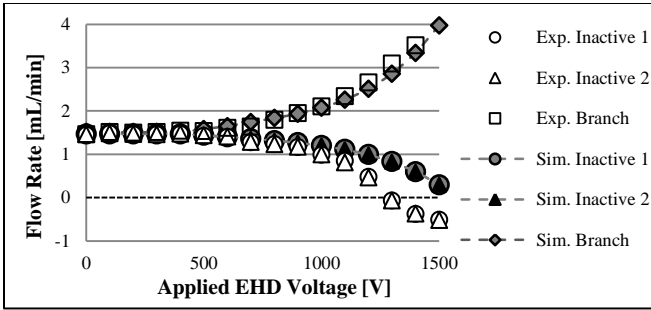

Fig. 2. Meso-scale flow rate redistribution with initially equal 1.5 mL/min distribution [12]

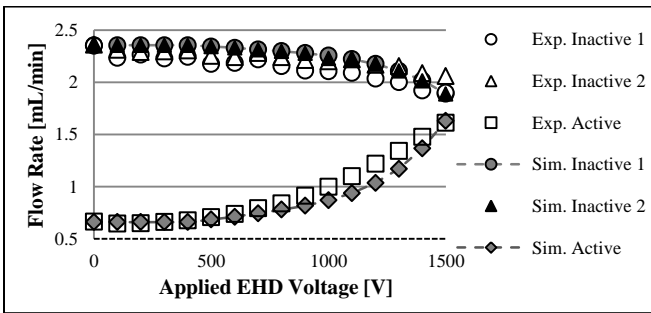

Fig. 3. EHD Conduction Pumping Mechanism [12]

## II. EXPERIMENTAL SETUP

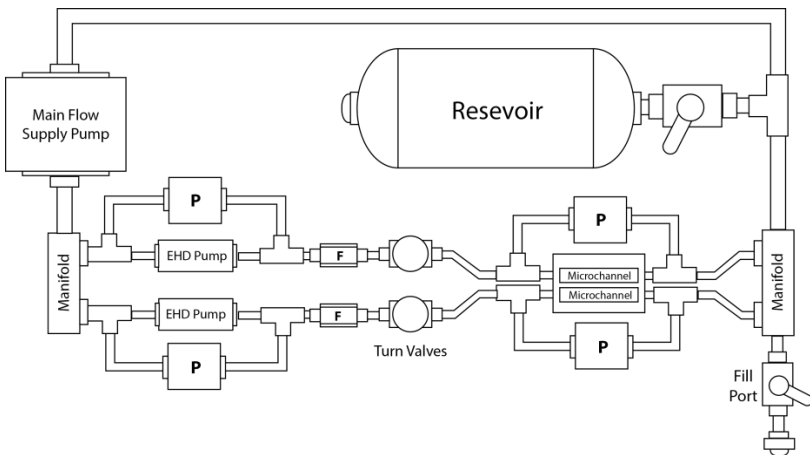

Fig. 4. Schematic of parallel microchannel experimental setup

The schematic for the experimental setup used in this study is shown in Fig. 4. The flow rate was supplied to the parallel branches via a Cole Parmer Model 75211-10 mechanical pump. A manifold split the flow generated by the supply pump into two

branches. Each branch contained a circular channel EHD conduction pump with 20 electrode pairs and a flow channel diameter of 1mm. Downstream of the EHD pump was a sample chip assembly containing the parallel, separate microchannels. The branches converged again at another manifold, which fed back into the supply pump, completing the loop. The branch distribution control pumps were highly reliable, meso-scale EHD conduction pumps with a well-known performance based on previous studies [13]-[14]. These pumps had an operational voltage between 0kV and 1.5kV. The electrode design for the pumps is depicted in Fig. 5, with electrode dimensions given in Table 1. Each EHD pump was instrumented with a Validyne DP15 pressure transducer and a micro-flow Sensirion SLQ-HC60 flow meter. The systematic measurement error, calculated based on the information provided by the manufacturers of the sensors and power supply, is shown in Table 2.

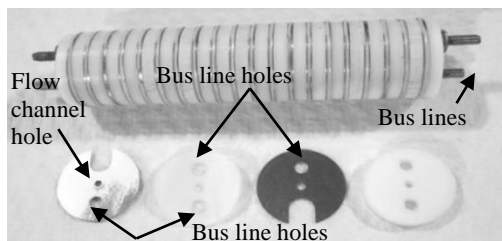

Fig. 5. Distribution control EHD conduction pump [13]

TABLE 1: BRANCH PUMPS ELECTRODE DIMENSIONS [13]

Dimension	Value
HV Electrode Width	0.381 mm
Electrode Spacer Width	0.127 mm
Ground Electrode Width	0.127 mm
Pair Spacer Width	1.588 mm

TABLE 2: SYSTEMIC MEASUREMENT ERRORS

Measurement	Error
Flow Rate	$\pm 0.15$ mL/min
Branch Pressure	$\pm 2$ Pa
Overall Pressure	$\pm 4$ Pa
Power Supply Voltage	$\pm 30$ V
Power Supply Current	$\pm 2$ $\mu$ A

Precise turn valves on each branch allowed for control of the initial distribution. This ensured that the baseline distribution could be made to either be equal across all branches or purposefully unequal – in order to observe the effectiveness of the distribution control and flow stabilization capabilities of the system. Due to power supply constraints, all EHD pumps were connected to the same voltage input, such that each pump that was

connected to the supply received the same voltage. However, each pump could be disconnected from the communal voltage independently from the others via a switching board specifically constructed for use in this experiment. The data acquisition system was comprised of two National Instruments boards, to accommodate the many differential sensors involved, the necessary inputs for voltage and current monitors and the necessary control outputs. The primary board was a National Instruments NI-PCI 6024e and the secondary board was a National Instruments NI-USB-6009. Both were connected to a LabVIEW program on a dedicated computer. The working fluid was the HCFC-123 refrigerant (commonly referred to as R-123). The electric [15] and thermodynamic [16] properties of this working fluid are shown in Table 3.

TABLE 3: HCFC-123 PROPERTIES AT 25°C [15], [16]

Property	Value
Liquid Density	1463 kg/m <sup>3</sup>
Dynamic Viscosity	0.456 mPa-s
Dielectric Strength	12 kV per mm
Dielectric Constant	4.6
Electric Conductivity	2.7E-8 S/m

### III. RESULTS AND DISCUSSION

The preliminary results presented here are for flow redistribution of an initially equal distribution, with different externally applied flow velocities. Fig. 6 shows a case with an initial 1.35 mL/min in each branch, corresponding to a mass flux of about 90 kg/m<sup>2</sup>s to the system. As one EHD pump is activated from 0V to 1500V, the flow begins to diverge, with the divergence initiation point being almost immediate, at 200V. This case shows that flow redistribution at this size scale was very effective for this flow rate. Flow starvation of the inactive microchannel was also still possible at this size scale and with this initial flow distribution. This shows that despite the greatly increased pressure load due to the reduced channel size to 500 microns, the EHD conduction pumps were still able to have a significant effect on the flow distribution.

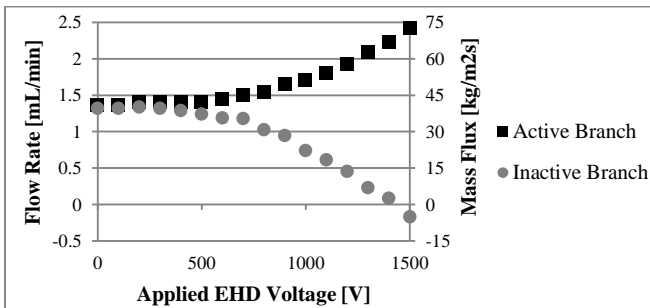
Fig. 6. Flow starvation in inactive branch, with 42 kg/m<sup>2</sup>s initially equal distribution

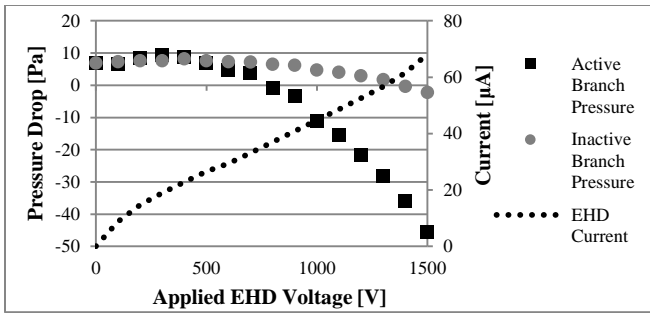

Fig. 7. Pressure drop and current load for 1.35 mL/min initially equal distribution

Fig. 7 shows the pressure drops in each branch, as well as the consumed current for the active EHD conduction pump. As previously mentioned, the current expectedly remained on the order of tens of  $\mu\text{A}$ , making the maximum power consumption consumed by the EHD pump for this case only 0.1 W at the highest applied voltage. The pressure drop is shown to significantly decrease in the active branch due to the pressure generation of the EHD conduction pump. The smaller decrease in the pressure drop in the inactive branch is attributed to the reduction in flow rate through that branch, which reduced the frictional pressure losses in that branch.

Fig. 8 shows a case with a higher initial flow rate distribution of 2.1 mL/min in each branch was used, corresponding to a total mass flux of  $130 \text{ kg/m}^2\text{s}$  to the system. In this case, the EHD conduction pump was able to obtain a separation of  $76 \text{ kg/m}^2\text{s}$ , with the active branch achieving  $104 \text{ kg/m}^2\text{s}$  at the maximum applied voltage. Flow starvation was not observed, and the point of divergence in the flow rates between the two branches was delayed to 600V, as shown. This matches the trend observed by Yang et al. [12] for meso-scale EHD conduction driven flow distribution. This delayed divergence effect is attributed to both the greater frictional losses that arise from the increased flow rate, as well as the effects of the incoming flow velocity on the formation and layer thicknesses of the heterocharge layers. In this figure we also observe a slight bowing of the flow rate curves, wherein the flow rate in the active branch decreases before increasing and the flow rate in the inactive branch increases before decreasing.

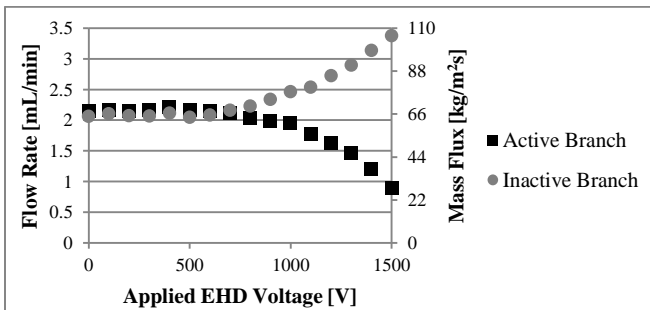

Fig. 8. Flow redistribution, with 2.1 mL/min initially equal distribution

Fig. 9 shows the corresponding pressure drops and current. The pressure drop is shown to grow in the active branch before the EHD pump’s pressure generation reverses the trend and flow divergence begins. The pressure drop also grows in the inactive branch due to the temporary increase in flow rate, and therefore the frictional losses in the inactive branch, before being reduced due to the flow being redirected to the active branch.

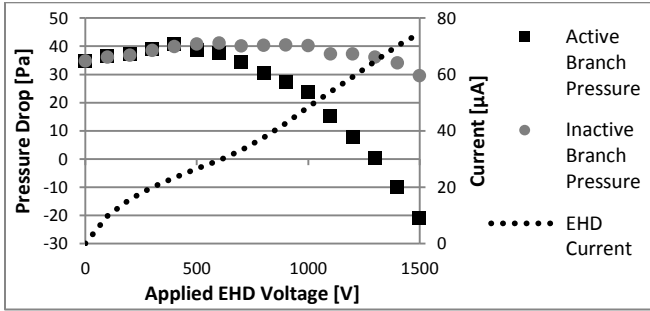

Fig. 9. Pressure drop and current load for 2.1 mL/min initially equal distribution

Fig. 10 shows a near-limiting case for the capability of the EHD conduction pump to diverge the flow using this micro-scale configuration. In this figure, an initially equal distribution of 4.5 mL/min was used, corresponding to a total mass flux of  $280 \text{ kg/m}^2\text{s}$ . Under this condition, the EHD pump was not able to have a noteworthy positive effect on the flow divergence until 1200V, and the final divergence at the maximum applied voltage of 1500V was only  $20 \text{ kg/m}^2\text{s}$ . Additional experiments have shown that the EHD pump ceases to have an effect on the flow distribution at 5mL/min in each branch. This is lower than the limit shown for the meso-scale experiments [12], but still within the same order of magnitude. This implies that while the greater frictional losses due to the micro-channels’ size have a limiting effect on the flow rate range at which EHD conduction can be used to control the flow distribution, the performance of the EHD conduction driven flow distribution system in micro-scale is still comparable to that at larger scales. The curve bowing shown in Fig. 10 is more significant than in Fig. 8, showing that this behavior becomes severe at this size scale near the effective flow rate limit, due to the additional pressure losses from the increase in flow rates.

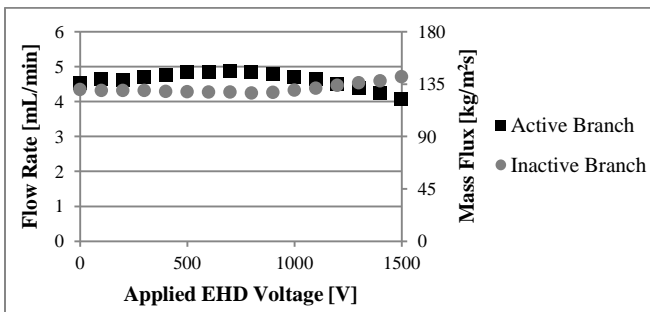

Fig. 10. Flow redistribution, with 4.5 mL/min initially equal distribution



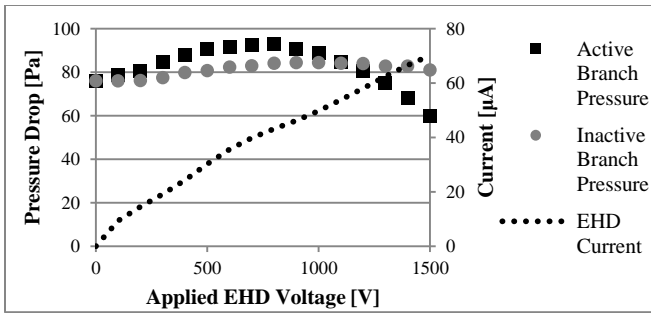

Fig. 11. Pressure drop and current load for 4.5 mL/min initially equal distribution

Fig. 11 shows the pressure drops and current for this case. The pressure drop in the active branch does not dip below its original value until the point of divergence, before which no pressure generation occurs. The pressure drop is also shown to increase in the active branch at the voltage levels prior to divergence, implying that activating the pump at lower voltages near its operational limit was working against the flow. Therefore, even though divergence does occur in this case, for the majority of the applied voltage range the EHD pump was actually working against the flow rather than aiding it, making operating near the divergence limit overall undesirable for this sort of system. Understanding how to minimize this unwanted effect near the flow rate limit will be of great value for any thermal control systems at these scales that relies on EHD conduction pumping technology.

The limit of capability for flow divergence for this system is understandable when considering the static pressure generation curve for the EHD conduction pumps used here, which is given in Fig. 12 for HCFC-123. The calculated pressure drop for the entire loop, based on the pipe diameters and the obtained experimental data, at the observed limit of 5 mL/min is on the order of 270 Pa. This value is comparable to the static pressure generation capability of the EHD pump at the maximum applied voltage, as shown in Fig. 12.

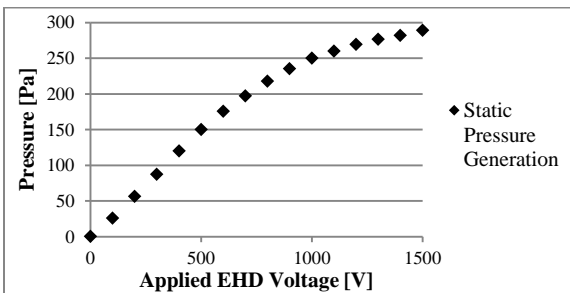

Fig. 12. Static pressure generation in HCFC-123

A comparative analysis between the limits of performances, in terms of mass fluxes, for the EHD conduction driven flow distribution systems studied thus far at different size scales is shown in Table 4. In this table, the second column describes the minimum mass flux at which complete flow starvation of the inactive branch was achieved, while the

third column shows the mass flux value at which the EHD driven system is no longer able to diverge the flow between the branches. For the macro-scale study this value had to be estimated based on an extrapolation from the given data in the original study [11] and the trends observed in meso-scale and in the current study, since the original study did not investigate this limiting case. The data suggests that although the flow channel sizes reduce by an order of magnitude between the different size scales, the EHD driven flow distribution system still had comparable performance at all scales. This shows that such a system is capable of directing small-scale flows as effectively as large-scale flows. It should be noted that the data shown in Table 4 for each size scale was obtained using EHD pumps with different geometries and different numbers of electrode pairs. Since those parameters can alter the resulting flow distribution performance, the data is given here merely as an illustrative tool to showcase general trends between the different size scales, rather than definitive limits on the performance of EHD conduction driven flow distribution systems at different size scales.

TABLE 4: COMPARISON OF SCALE DEPENDENT MASS FLUX REDISTRIBUTION CAPABILITIES AT MAX. VOLTAGE

Size Scale	Inactive Branch Starvation Total Mass Flux	Maximum Total Mass Flux for Divergence
Macro Scale [11]	100 kg/m <sup>2</sup> s	600 kg/m <sup>2</sup> s (Est.)
Meso Scale [12]	90 kg/m <sup>2</sup> s	500 kg/m <sup>2</sup> s
Micro Scale	70 kg/m <sup>2</sup> s	310 kg/m <sup>2</sup> s

#### IV. CONCLUSION

The work presented here has demonstrated preliminary results for the performance characterization of an EHD conduction driven, single phase flow distribution system for parallel microchannels. The results show that EHD conduction driven flow distribution is still effective in a micro-scale system, and has comparable performance in terms of mass fluxes to similar systems at larger size scales that have been previously investigated. This confirms the potential for effective EHD conduction driven thermal control systems at the micro-scale, making this technology desirable for small-scale electronics cooling. To obtain the full characterization of the flow redistribution and recovery from maldistribution capabilities of this system, as well as an understanding of what occurs near the flow rate limit at small scales, further studies still need to be performed.

#### ACKNOWLEDGEMENTS

This work was financially supported by the NASA Headquarters Micro-Gravity Fluid Physics Program. The second author's work was also sponsored by a NASA Space Technology Research Fellowship.

## REFERENCES

- [1] J. Seyed-Yagoobi, "Electrohydrodynamic pumping of dielectric liquids", *Journal of Electrostatics*, vol. 63, pp. 861-86, Jun. 2005.
- [2] A. Castellanos, "Conduction models in dielectric liquids," in *Electrohydrodynamics*, Springer Vienna, 1998, pp. 103-120.
- [3] M. Yazdani and J. Seyed-Yagoobi, "Electrically Induced Dielectric Liquid Film Flow Based on Electric Conduction Phenomenon", *IEEE Transactions on Dielectrics and Electrical Insulation*, vol. 16, pp. 768-77, Jun. 2009.
- [4] M. Yazdani and J. Seyed-Yagoobi, "Effect of Charge Mobility on Dielectric Liquid Flow Driven by EHD Conduction Phenomenon", *Journal of Electrostatics*, vol. 72, pp. 285-294, Aug. 2014.
- [5] S. I. Jeong, and J. Seyed-Yagoobi, "Innovative Electrode Designs for Electrohydrodynamic Conduction Pumping," *IEEE Transactions on Industry Applications*, Vol. 40, No. 3, pp. 900-904, May 2004.
- [6] P. Atten, and J. Seyed-Yagoobi, "Electrohydrodynamically Induced Dielectric Liquid Flow through Pure Conduction in Point/Plane Geometry", *IEEE Transactions on Dielectrics and Electrical Insulation*, vol. 10, pp. 27-36, Feb. 2003.
- [7] S. R. Mahmoudi, K. Adamiak and G.S.P. Castle, "Prediction of the Static Pressure Generation for an Electrohydrodynamic Conduction Pump", presented at the 17th IEEE International Conference on Dielectric Liquids, Trondheim, Norway, 2011.
- [8] M. R. Pearson and J. Seyed-Yagoobi, "Experimental study of EHD conduction pumping at the meso- and micro-scale", *Journal of Electrostatics*, vol. 69, pp. 479-485, Dec. 2011.
- [9] V. K. Patel, and J. Seyed-Yagoobi, "Dielectric fluid flow generation in meso-tubes with micro-scale electrohydrodynamic conduction pumping", presented at the 17th IEEE International Conference on Dielectric Liquids, Trondheim, Norway, 2011.
- [10] M. R. Pearson, and J. Seyed-Yagoobi, "Advances in Electrohydrodynamic Conduction Pumping", *IEEE Transactions on Dielectrics and Electrical Insulation*, vol. 16, pp. 424-434, Apr. 2009.
- [11] Y. Feng and J. Seyed-Yagoobi, , "Control of Liquid Flow Distribution Utilizing EHD Conduction Pumping Mechanism", *IEEE Transactions on Industry Applications*, Vol. 42, No. 2, pp. 369-377, Mar. 2006.
- [12] L. Yang, M. Talmor, K. S. Minchev, C. Jiang, B. C. Shaw and J. Seyed-Yagoobi, "Flow distribution control in meso scale via electrohydrodynamic conduction pumping." Proceedings of the IEEE Industry Applications Society, Dallas, TX, USA, 2015.
- [13] V. K. Patel, F. Robinson and J. Seyed-Yagoobi, "Terrestrial and Microgravity Experimental Study of Microscale Heat-Transport Device Driven by Electrohydrodynamic Conduction Pumping", *IEEE Transactions on Industry Applications*, vol. 49, pp. 2397-2401, Nov. 2013.
- [14] V. K. Patel and J. Seyed-Yagoobi, "Long-Term Performance Evaluation of Microscale Two-Phase Heat Transport Device Driven by EHD Conduction." *IEEE Transactions on Industry Applications*, vol. 50, pp. 3011-3016, Sep. 2014
- [15] J. E. Bryan, "An experimental study of ion-drag pumping in a vertical axisymmetric configuration," Ph.D. dissertation, Department of Mechanical Engineering, Texas A&M University, College Station, TX, 1990.
- [16] M. O. McLinden, et al., "NIST thermodynamic and transport properties of refrigerants and refrigerant mixtures," NIST, Gaithersburg, MD, Rep. REFPROP 6.01, Jan. 1998